

LINKEX™ LED FLOODLITE

WF-300® XL



OPERATION AND MAINTENANCE INSTRUCTIONS

Wolf WF-300XL LED Floodlight Operation & Maintenance Instructions

Please Retain – Read Before Use

EU Declaration of Conformity

The Wolf WF-300XL LED Floodlight meets all relevant provisions of the 2014/34/EU Explosive Atmospheres (ATEX Equipment) Directive by virtue of the issued EU Type Examination Certificate, demonstrating compliance with all relevant Harmonised Standards and Essential Health and Safety Requirements.

The Wolf WF-300XL LED Floodlight is a high performance lightweight portable floodlight, constructed from marine grade aluminium with a powder coated finish and toughened glass lens. The Floodlight is Group II, Category 2 equipment for use in zone 1, 2, 21 and 22 potentially explosive gases, vapours, mists and dusts where the T4 temperature class/118°C maximum surface temperature permits. The Floodlight is certified for use with the Wolf accessories listed in these instructions.

Approval Code:

II 2GD
 Ex eb mb IIC T4 Gb
 Ex tb IIIC T118°C Db.
 Ta = -40°C to +55°C or Ta = -40°C to +40°C when the WF-462 optional Protection Cover is fitted

Ensure any replacement cable is rated for the lower ambient temperature the product will be used in and a +80°C minimum upper rating.

EU Type Examination Certificate: **CML18ATEX3372X**

Notified Body: SGS FIMKO O.Y. P.O. Box 30
 [Särkiniementie 3] 00211 HELSINKI, Finland

Notified body number: **0598**

Harmonised standards applied:- EN IEC 60079-0:2018, EN IEC 60079-7:2015+A1:2018, EN 60079-18:2015+A1:2017, IEC 60079-31:2022.

Ingress protection level IP66 & IP67 to EN60529:1992.

Wolf WF-300XL LED Floodlights are manufactured in accordance with the 2014/30/EU EMC Directive to the following standards:- EN 55015:2019, EN 61000-3-2:2014, EN 61000-3-3:2013, EN 61547:2009.

This declaration is issued under the sole responsibility of Wolf Safety Lamp Company.



Alex Jackson – Managing Director
 Wolf Safety Lamp Company Ltd
 Sheffield, S8 0YA, UK
 Dated: 01 December 2021

UK Declaration of Conformity

The Wolf WF-300XL LED Floodlight meets all the statutory requirements of the Equipment and Protective Systems Intended for Use in Potentially Explosive Atmospheres Regulations 2016, UKSI 2016/1107 as amended by UKSI 2019/696 by virtue of the issued UKEX type examination certificate, demonstrating compliance with all relevant designated standards and essential health and safety requirements.

Approval Code:

II 2GD
 Ex eb mb IIC T4 Gb
 Ex tb IIIC T118°C Db.
 Ta = -40°C to +55°C or Ta = -40°C to +40°C when the WF-462 optional Protection Cover is fitted

Ensure any replacement cable is rated for the lower ambient temperature the product will be used in and a +80°C minimum upper rating.

Approved Body: SGS Baseefa Ltd, Rockhead Business Park, Staden Lane, Buxton, SK17 9RZ, UK.

Approval body number: **1180**

UK Type examination certificate: **CML 21UKEX3645X**

Designated Standards Applied:

EN IEC 60079-0:2018, EN IEC 60079-7:2015+A1:2018, EN 60079-18:2015+A1:2017, IEC 60079-31:2022.

Wolf WF-300XL LED Floodlights also meet all the statutory requirements of the UK EMC Regulations 2016, UKSI 2016/1091 as amended by UKSI 2019/696 to the following relevant designated standards:- EN 55015: 2019, EN 61547: 2009, EN 61000-3-2:2014, EN 61000-3-3:2013.

This declaration is issued under the sole responsibility of Wolf Safety Lamp Company.



Alex Jackson – Managing Director
 Wolf Safety Lamp Company Ltd.
 Sheffield, S8 0YA, UK.
 Dated 01 December 2021

Photobiological safety to EN 62471:2008

Wolf WF-300XL LED Floodlight: Risk Group 2

CAUTION: Possibly hazardous optical radiation emitted from this product. Do not stare at operating lamp. May be harmful to the eye.

IECEx Scheme Certification

Certificate Number: IECEx CML 18.0198X

Ex eb mb IIC T4 Gb

Ex tb IIIC T118°C Db

Ta = -40°C to +55°C or Ta = -40°C to +40°C when

the WF-462 optional Protection Cover is fitted

IEC Standards applied: IEC60079-0:2017, IEC60079-7:2015, IEC60079-18:2014, & IEC 60079-31:2022.

SPECIAL CONDITIONS OF USE (X CONDITION)



The Floodlight enclosure coated surfaces are non-conducting and may generate an ignition-capable level of electrostatic charge under certain extreme conditions. The equipment shall not be installed in a location where the external conditions are conducive to the build-up of electrostatic charge on these non-conductive surfaces. Additionally, the equipment shall only be cleaned with a damp cloth.

The Floodlight can be fitted with a protective cover (WF-462), when fitted the maximum ambient temperature lowers from +55°C to +40°C. Use only Wolf supplied accessories.

Equipment Use

Check the rating label to ensure the Floodlight is suitable for the supply provided, ambient temperature present and the environmental conditions.

- It is the user's responsibility to ensure there is no potential difference between the earth supply to a Floodlight unit and the local earth in the work area. Where this is not possible the equipment should be securely earth bonded to metalwork in the immediate vicinity of where the Floodlight is being used. A flexible cable is recommended (6mm² minimum, no more than two metres long), connected to the earth grounding point on the Floodlight enclosure. Floodlights must be de-energised during connection or disconnection of the local earth bond.
- Safe/Optimal Voltage Indicator (SOVI). The Wolf WF-300XL LED Floodlight incorporates SOVI technology to highlight to the user if the product is operating outside of the certified maximum and recommended minimum voltage range.
- The diagram below represents the SOVI function, it demonstrates that when the voltage is not within the "Safe/Optimal Voltage" the light output will change from a constant uninterrupted beam to a pulse.

SOVI	LAMP OFF	SAFE OPTIMAL VOLTAGE	UNSAFE VOLTAGE
WF-300XLH	< 90V	90-100V	100-264V
WF-300XLL	< 18V	18-19V	19-50V
LIGHT OUTPUT	OFF	PULSE	ON
			

- The Floodlite is approved with a range of protective consumable accessories that are designed to protect and extend its maintained lifecycle. These accessories should be replaced when damaged or the light output is obscured.
- When the polycarbonate Floodlite Lens Guard (WF-421) is fitted to the Floodlite, the end user must ensure that this is suitable for the atmosphere the Floodlite will be used in.
- Inspect seals. Silicone seals are used in the construction of the lamp. Where conditions could include exposure to chemicals that may react with silicone, seek further advice.
- If connecting a large number of Floodlites check for SOVI indication on all the lamps in the string. Guidance on lamp connection and extensions can be found at www.wolfsafety.com
- This product is Class 1 equipment and must be earthed. Floodlites are supplied as standard with 3 core earthed supply cables. Where the user specifically requires a 24 volt SELV Floodlite with 2 core cable (+ve and -ve) / a 2 pole plug, the Floodlite must be used with a separate connection to earth via the external earth grounding point.
- All Floodlites have terminal blocks suitable for incoming cables for up to 4mm² conductor capacity.
- Ex "e" certified Increased Safety terminal blocks must have all terminals fully tightened down even if a conductor is not fitted. On all terminal blocks, tighten screws to 0.5-0.7Nm.
- ATEX/IECEx approved cable glands must be used and be suitable for the type of cable used. Any unused cable entries should be blanked off with a suitable ATEX/IECEx approved stopper plug to maintain a minimum IP67 rating and temperature rating as marked on the label.
- Floodlites and cable should be inspected prior to each use for visible signs of damage. Particular attention should be paid to gland and socket entries. Damaged lamps should be removed from the work area and repaired before being put back in service.
- Plugs must be connected and fully engaged in the correct socket to maintain the IP rating of the plug and socket. WF-300XL LinkEx Floodlites and any connected power distribution equipment, fitted with a socket, must have the socket covers closed when not in use to maintain IP rating of the socket housing.

- IMPORTANT.** No modifications are permitted to the Floodlites, all spare parts must be purchased from the manufacturer, unauthorized modifications or spare parts will invalidate certification.
- Portable Appliance testing must be carried out to IEC, EN standards to the correct rating i.e. 250V DC for 18-50V versions and 500V DC for 90-264VAC versions. Live and neutral cables must be shorted together and the voltage applied between earth and this connection.

FRONT COVER

Remove the front cover by unscrewing the four socket head retaining bolts. Release the Earth connecting wire by releasing the locking spade connection in the floodlite by depressing the tab on the connector and pulling away. Perform repairs/maintenance as necessary. To reassemble follow the above points in reverse order. Take care not to trap/crush wires and ensure the seal is in good condition.

*The Certificate label and serial number are fitted to the front cover, therefore do not interchange the front covers with other WF-300XL Floodlites. See internal body label for serial number reference.

CHANGING CABLE OR SOCKET

See diagrams overleaf

Disconnect the input cable, release cable from input gland. Check the gland seal is in good condition, fit the new part(s) and re-assemble the product by following the stated procedure in reverse order.

If any change is made to cable, glands, plugs or sockets the manufacturers instructions should be adhered to, ensuring the seal between the item and the cable is reliable.

CHANGING LED PANELS

See diagrams overleaf

Each LED panel can be removed by unscrewing four socket head bolts and the wiring terminations. Discard the old panel and replace with a new one by following the removal procedure in reverse. A new thermal pad must be fitted on replacement under the LED panel as shown in the exploded diagram.

CHANGING LED DRIVERS

See diagrams overleaf

Unscrew the internal & external wiring terminations from the six & four way terminal blocks and remove the driver retention bracket by unscrewing the two bolts. One or both drivers can be replaced. To reassemble follow the above points in reverse order.

CHANGING GLASS LENS

See diagrams overleaf

Replace the glass by unscrewing the six socket head screws securing the three retaining plates. Fit the new glass making sure strip gasket material is fitted between the glass and each retention plate.

FAULT FINDING

 Risk of Shock

If a WF-300XL Floodlite fails to function, remove the product from service into a non hazardous area. Remove the cover and apply power to the Floodlite. Check the input voltage at the terminals is present and is the correct rating for the Floodlite. If the voltage is correct check the output voltage to the LED panels, this should be 19V DC +/-1V. If this voltage is not present then the driver is faulty, if it is then the LED panel is faulty. Replace as necessary.

DISPOSAL OF WASTE MATERIAL

Disposal of packaging, redundant LinkEx LED products and parts should be carried out in accordance with applicable regulations.

SPARE PARTS

See diagrams overleaf

The Wolf Safety Lamp Co. Ltd has a policy of continuous product improvement. Changes in design details may be made without prior notice.

TECHNICAL DATA

Enclosure		Marine grade aluminium alloy with a powder coated finish.
Lens		Toughened Glass
Light Source:	Type	36 x White High Power LEDs
	Life	100,000+ hrs
Weight		7.3kg (excluding cable)

ELECTRICAL DATA

Model	WF-300XLL	WF-300XLH
Voltage	18-50V AC/DC	90-264V AC only
Freq Hz	50/60	50/60
Total Circuit Power	≤ 55 Watts	≤ 62 Watts
VA (AC)	84VA at 24V AC 96VA at 42V AC 104VA at 48V AC	N/A

MAINTENANCE



EN IEC 60079- 17

- Only suitably qualified and experienced technicians are to assemble/disassemble the Floodlite.
- Isolate the Floodlite from the mains supply and allow to cool before carrying out any maintenance work.

SPARE PARTS

Item No.	Part No.	Part Description	Quantity
1	WF-552	Painted rear casting + seal and retaining bolts	1
2	WF-572	Painted front cover assembly, complete with glass	1
3	WF-554	Glass Lens, Seal and bracket pads	1
4	WF-586	18-50V LED Driver	1 (2 needed per Floodlite)
5	WF-592	90-264V LED Driver	1 (2 needed per Floodlite)
6	WF-558	LED Panel, Thermal pad and fixing screws	1 (2 needed per Floodlite)
7	WF-562	6 way -4mm ² Terminal Block, & 2 QB links and fixing screws	1
8	WF-564	4 way -4mm ² Terminal Block, and fixing screws	1
9	WF-587	LED Driver Retention Bracket (18-50V)	1
10	WF-589	LED Driver Retention Bracket (90-264V)	1
11	WF-560	Complete Driver Assembly Inc. Bracket and terminals (18-50V)	1
12	WF-570	Complete Driver Assembly Inc. Bracket and terminals (90-264V)	1
13	WF-584	Floodlite Enclosure Seal	1
14	WF-585	Floodlite Glass Seal	1
15	WF-576L	Internal Screw and Sticker Set 18-50V AC/DC	1
16	WF-576H	Internal Screw and Sticker Set 90-264V AC	1
17	WF-566	Internal Earth/Grounding wire set	1
18	WF-568	External Earth Stud	1
19	WF-590	Bridle Fixing Kit	1
20	WF-582	Frame & Bridle (No fixings incl.)	1
21	LL-311	Gland M20 x 1.5mm	1 (+1 LinkEx Versions)
22	WF-495	M20 stopping plug	1
23	WF-550	Certification label and bracket are specific to the individual product, contact your authorised Wolf supplier for replacement.	1

Contact your authorised Wolf supplier for replacement cables, plugs or link socket components.

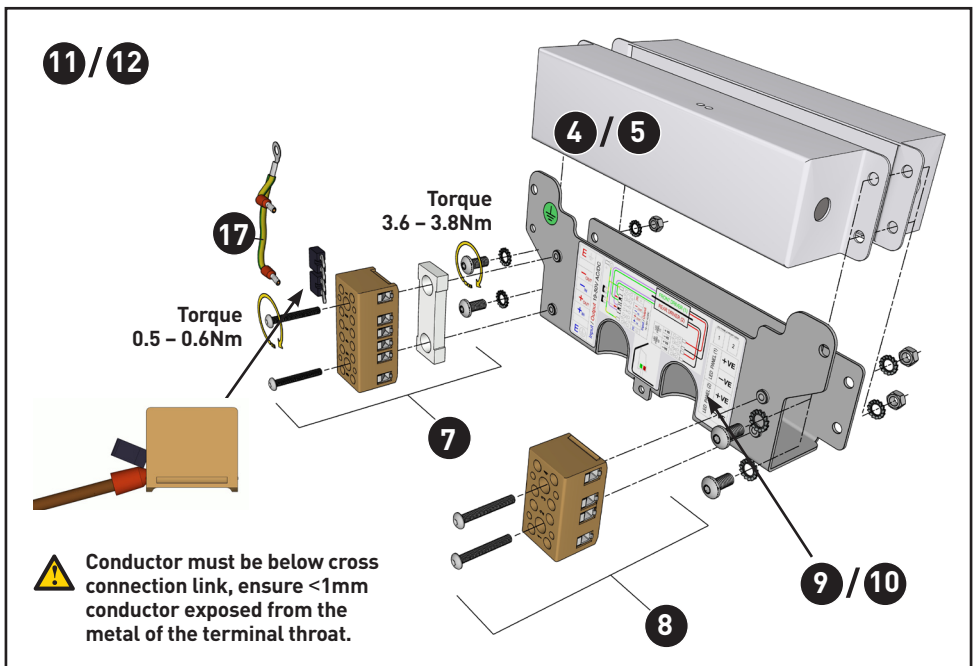

TERMINAL CONNECTING

 0.5-0.7Nm

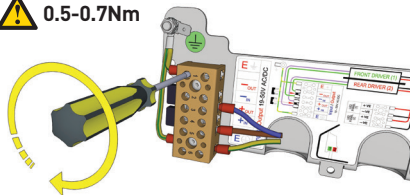

 Ensure $\leq 1\text{mm}$ conductor exposed from the metal of the terminal throat

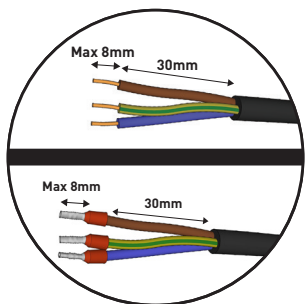

WIRING SCHEMATIC 18-50V

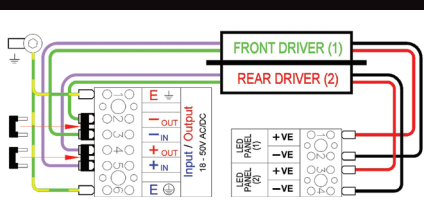

WIRING SCHEMATIC 90-264V

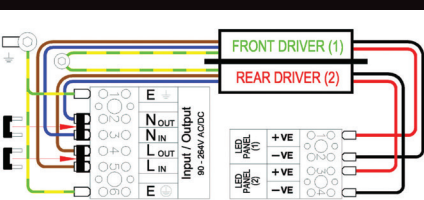

ACCESSORIES

Lens Guard Kit
WF-421

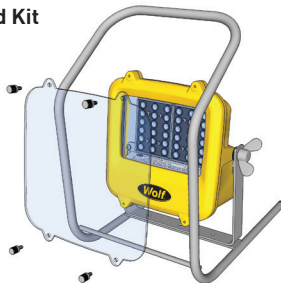

Mesh cover
WF-480

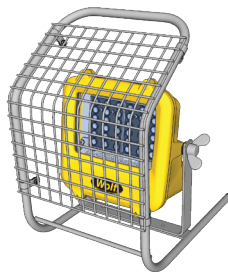

Magnet Kit
WF-545



Protection cover kit
WF-462



Note:



II 2GD
Ex eb mb IIC T4 Gb [-40°C ≤ T_a ≤ +40°C].
Ex tb IIIC T118°C Db

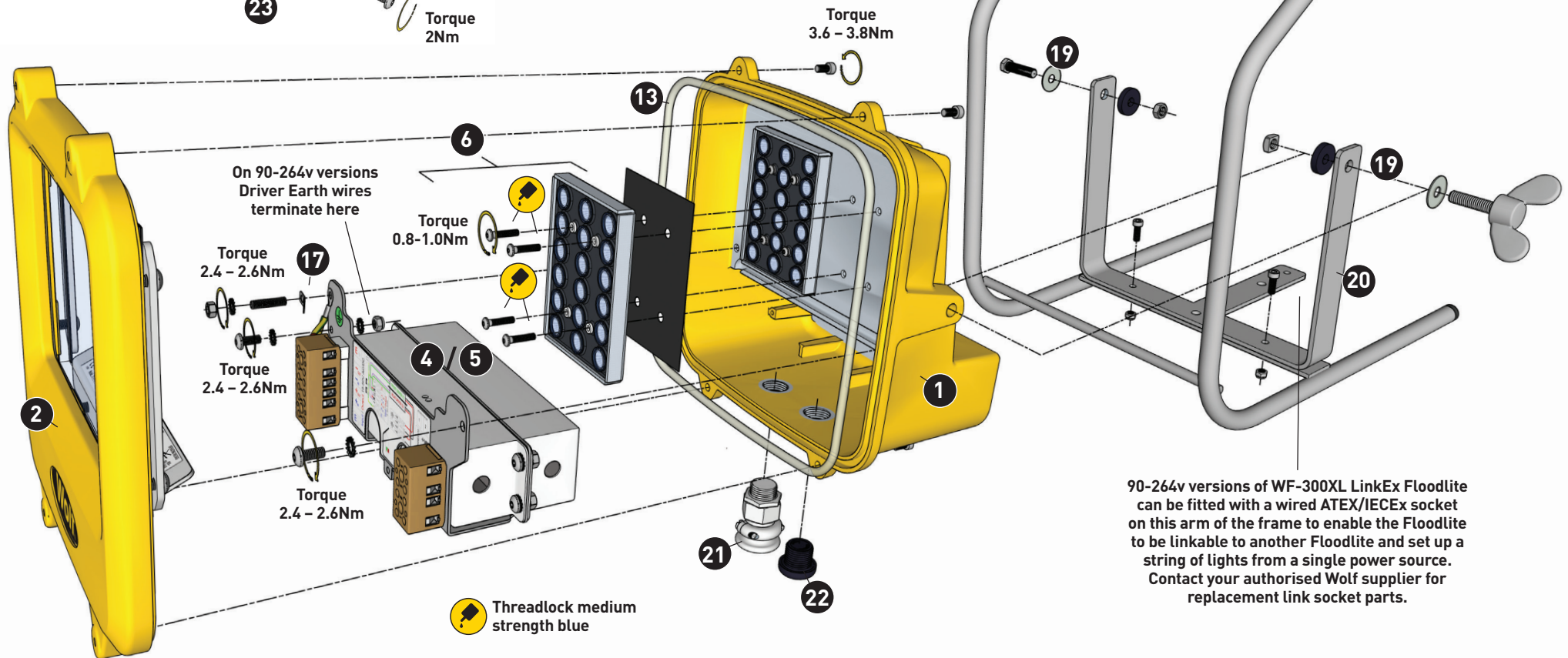
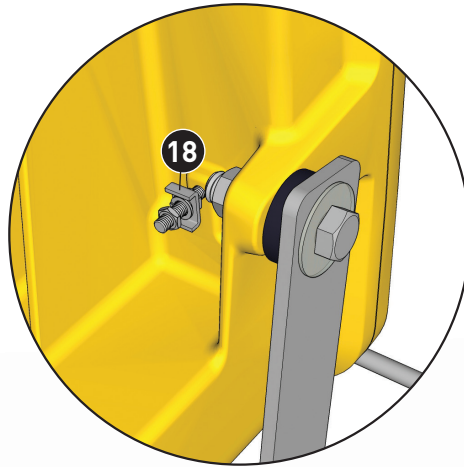
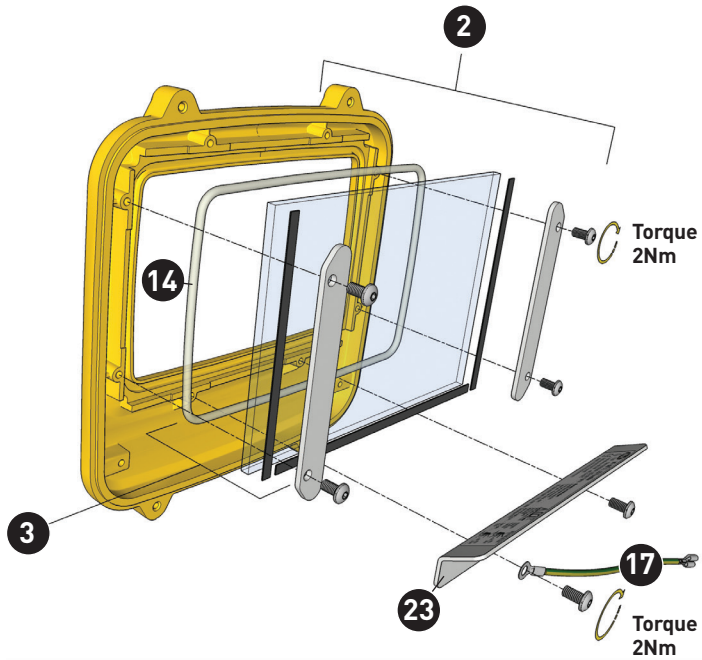

90-264v versions of WF-300XL LinkEx Floodlite can be fitted with a wired ATEX/IECEx socket on this arm of the frame to enable the Floodlite to be linkable to another Floodlite and set up a string of lights from a single power source. Contact your authorised Wolf supplier for replacement link socket parts.



LinkEx™ WF-300®XL LED Floodlite features

- Ideal for Task lighting and work activities in a hazardous area
- ATEX, UKEX and IECEx approved for Zone 1 and 21 explosive gas and dust atmospheres.
- High power 'fitted for life' LED light source
- High quality, even, ultra-wide angle LED light, reduces shadows and enhances visibility
- Medium angle flood beam
- Safe/Optimal Voltage Indication "SOVI" to ensure safe certified operation.
- ATEX/UKEX/IECEx Approved Floodlite Protection Accessories available

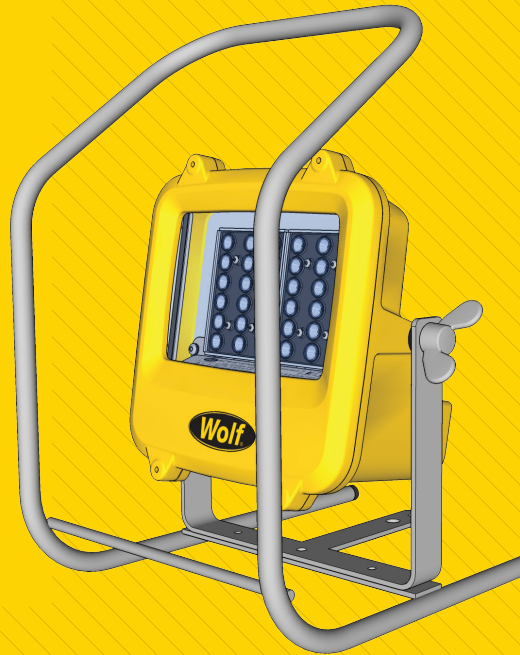

Authorised Representative (EU)2019R1020:
Authorised Representative Service,
77 Camden Street Lower, Dublin, D02 XE80. Ireland

WOLF SAFETY LAMP COMPANY

Saxon Road Works,
Sheffield, S8 0YA, UK

T: +44 114 255 1051

E: info@wolfsafety.com

W: www.wolfsafety.com



0598



1180

