

Fig. 1



EN IEC 60079:-

**IECEx Scheme Certification**

R-30 Zone 1 Halogen Bulb Model:  
**Ex e ib IIC T4 tD A21 IP67 T85C**  
Cert. No: **IECEx BAS 05.0070**

R-50 Zone 1 LED Model:  
**Ex ib IIC T4 tD A21 IP67 T85C**  
Cert. No: **IECEx BAS 06.0001**

R-55 Zone 0 LED Model:  
**Ex ia IIC T4 IP67**  
Cert. No: **IECEx BAS 06.0001**

IEC Standards Applied:  
IEC60079-0:2000, IEC60079-0:2004,  
IEC60079-11:1999, IEC60079-7:2001,  
IEC61241-0:2004, IEC61241-1:2004

Ingress Protection Level:  
IP67 to IEC60529:2001

Fig. 2



Fig. 3

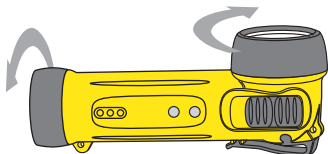

Fig. 4

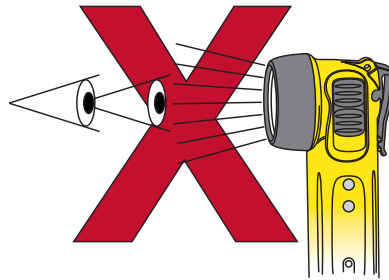
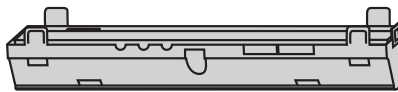

Fig. 5

R-271



Li Ion



-Un Transportation  
Regulations

-ADR  
-US CFR 49



-IATA  
-ICAO  
-IMDG



Fig. 6

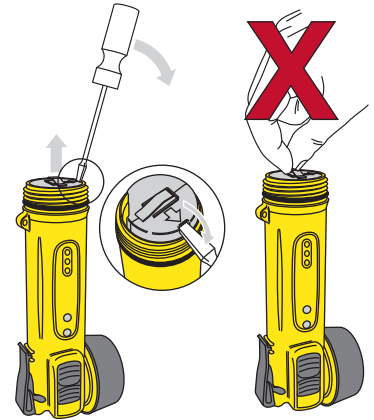

Fig. 7

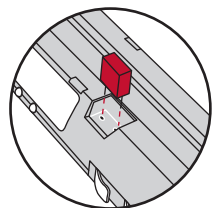
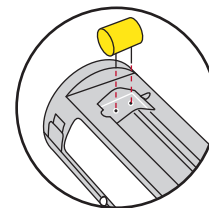
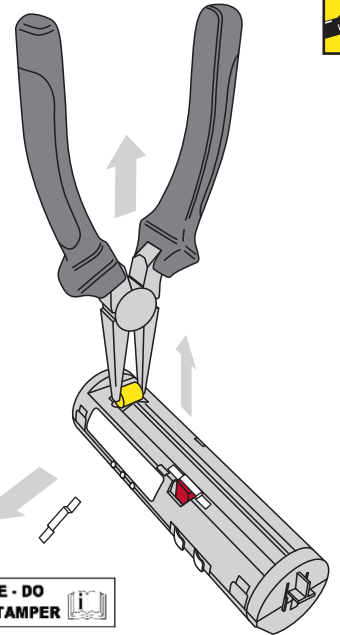

Fig. 8

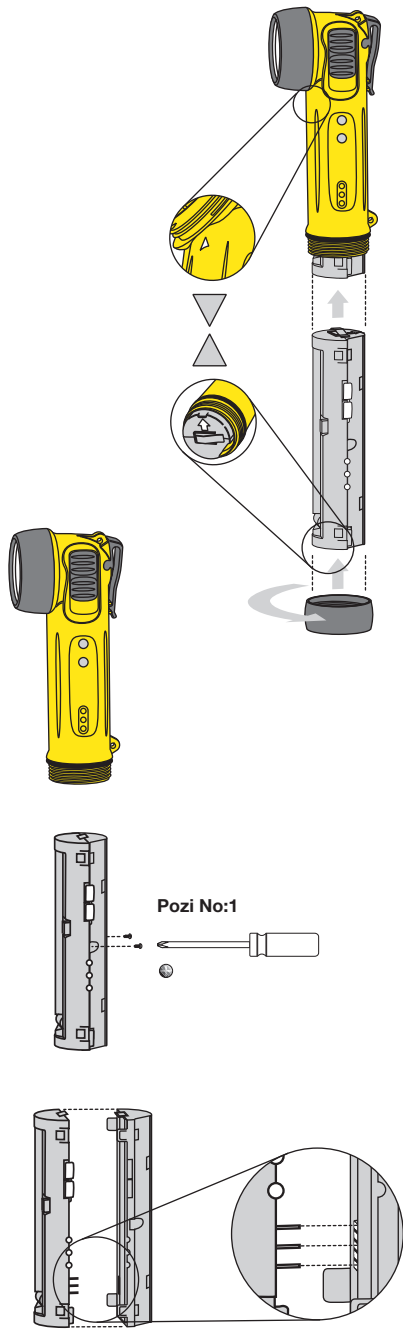

Fig. 9

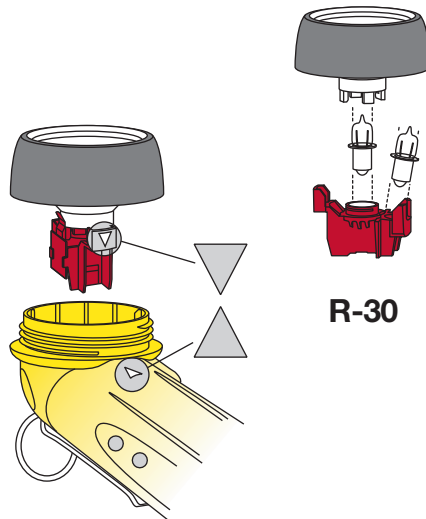

Fig. 10

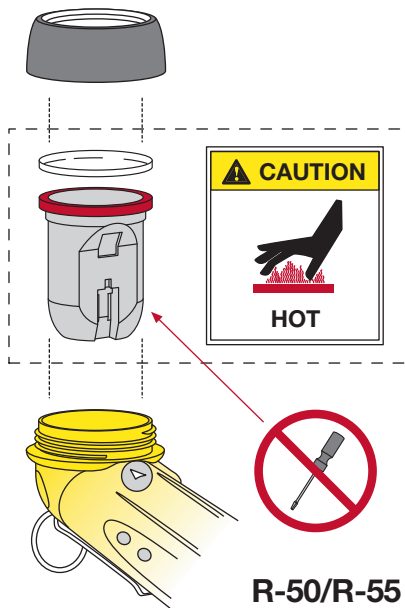

Fig. 11

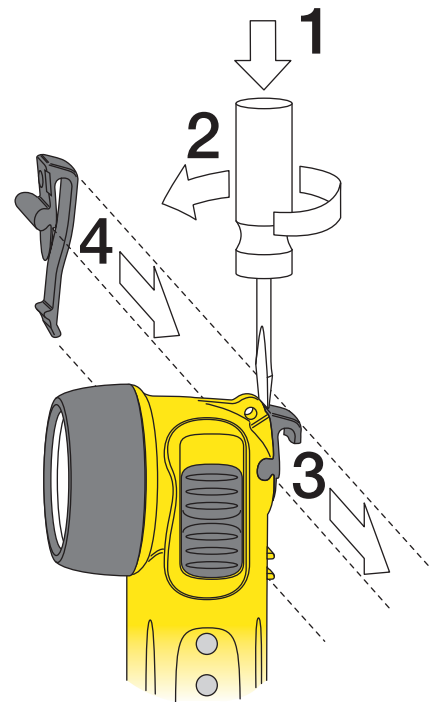

Fig. 12

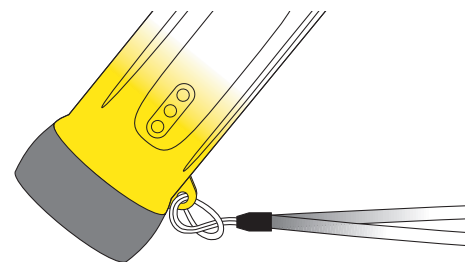

Fig. 13

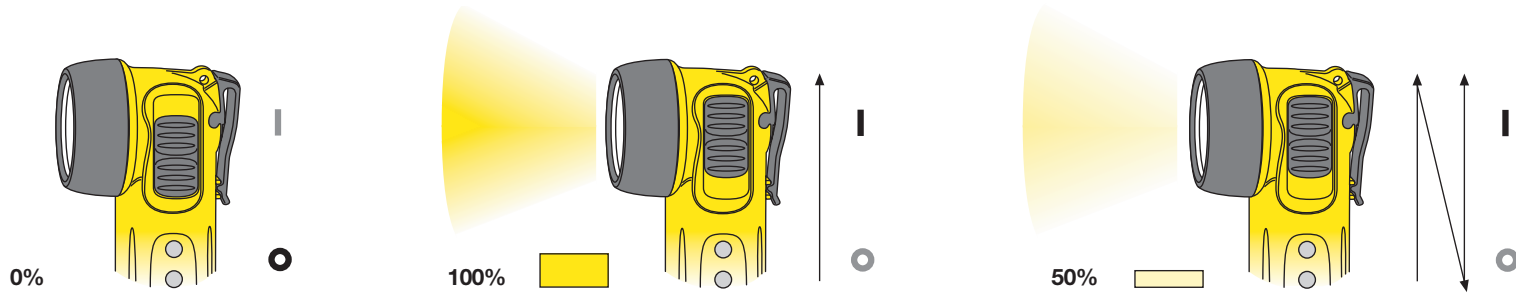

Fig. 14

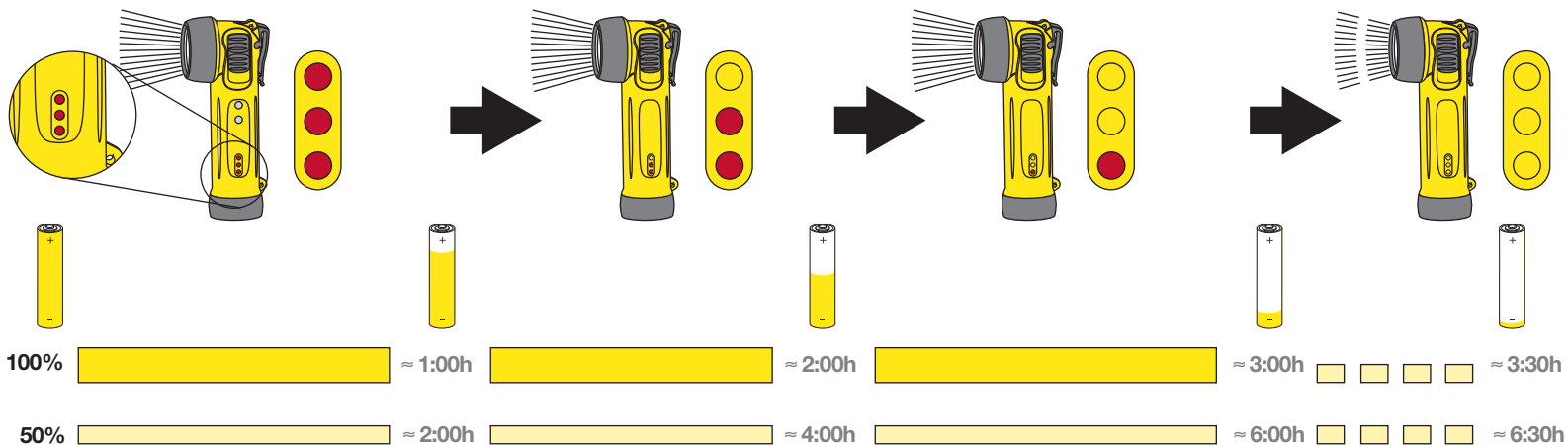
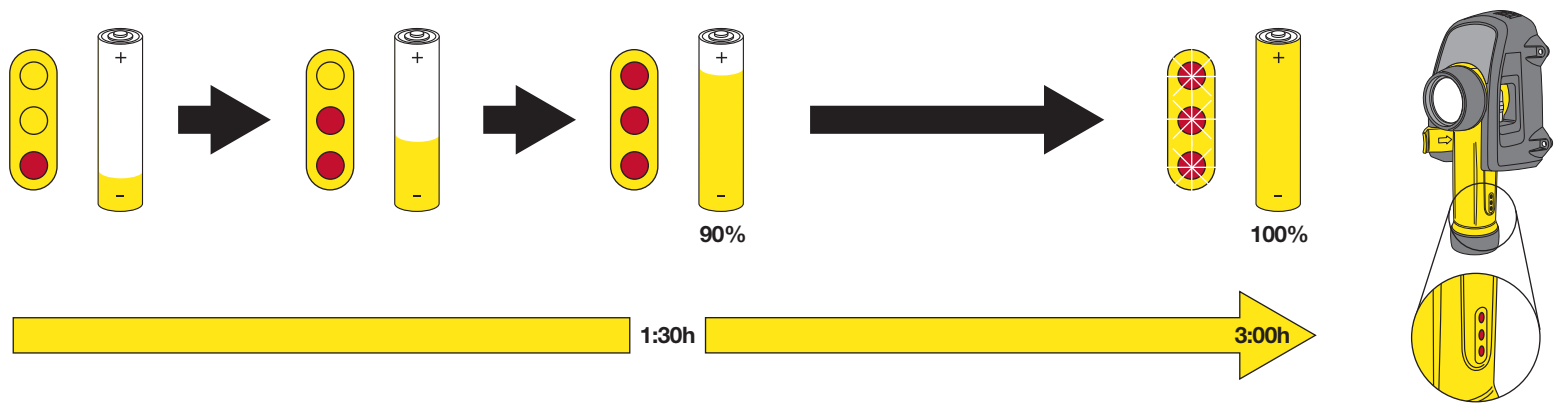
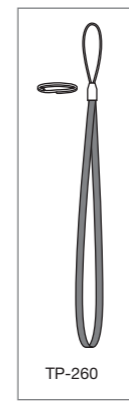
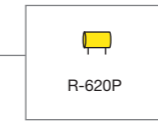
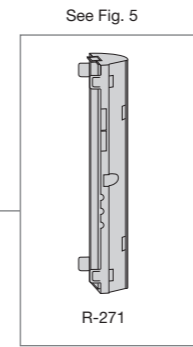
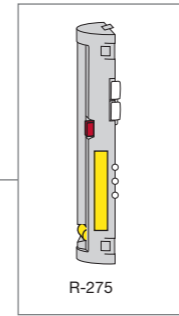
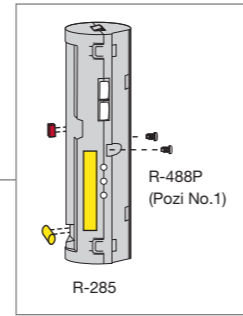
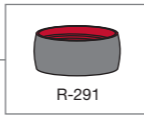
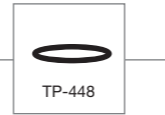
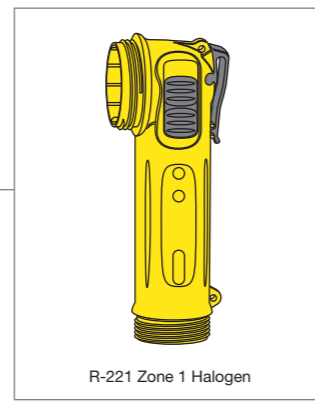
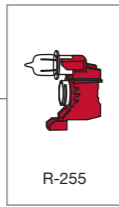
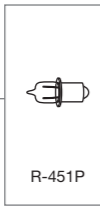
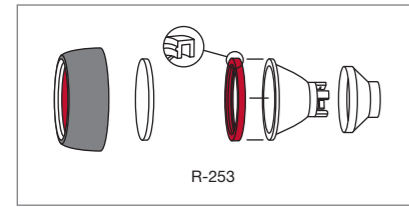

Fig. 15



### R-30



### R-50

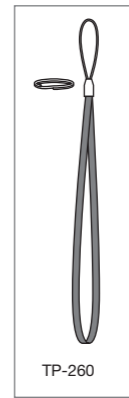
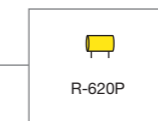
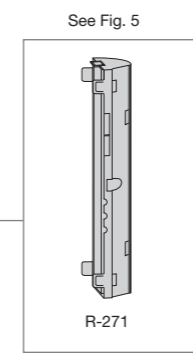
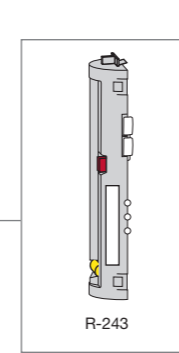
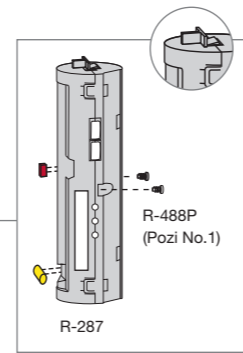
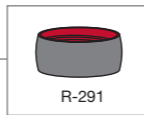
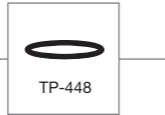
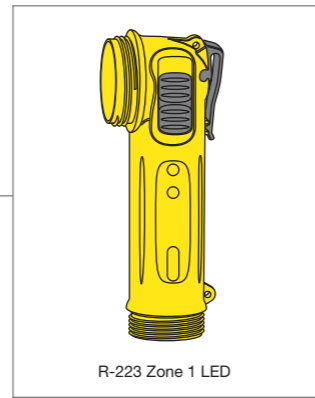
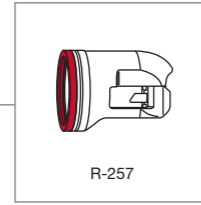
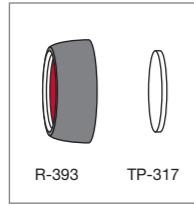

### R-55

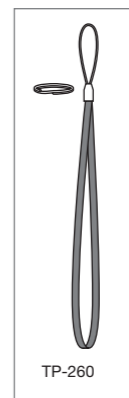
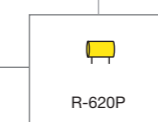
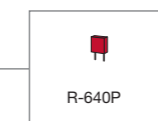
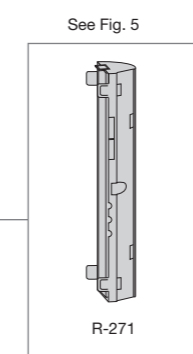
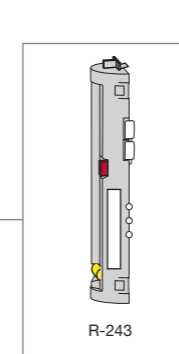
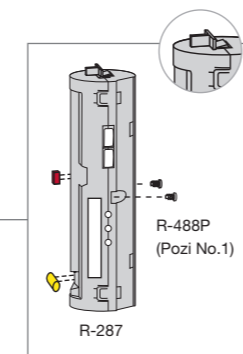
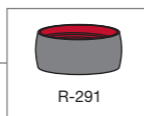
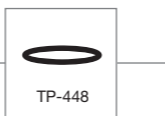
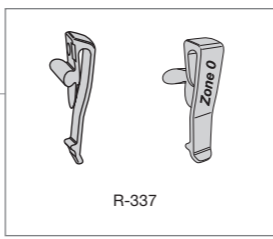
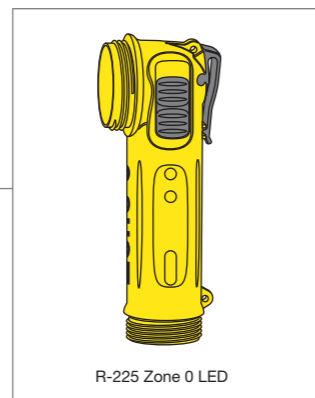
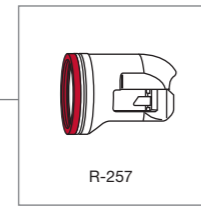
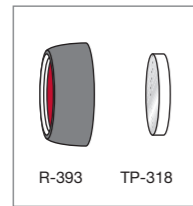

### Parts List

#### R-30

- R-253 Lens Ring Assembly
- R-255 Bulbholder Assembly with Bulb
- R-451P 6V 4W Halogen Bulb
- R-221 R-30 Torch Body Assembly
- TP-343 Clip Moulding
- R-285 Cassette Assembly (Bulb)
- R-275 Cassette Circuit Half (Bulb)
- R-271 Battery Pack
- R-488P Lock Screw Cassette (Pack of 2)
- TP-448 Base 'O' Ring
- R-291 End Cap Assembly

#### R-50

- R-393 Lens Ring
- TP-317 Lens
- R-257 Heatsink LED Assembly
- R-223 R-50 Torch Body Assembly
- TP-343 Clip Moulding
- R-287 Cassette Assembly (LED)
- R-243 Cassette Circuit Half (LED)
- R-271 Battery Pack
- R-488P Lock Screw Cassette (Pack of 2)
- TP-448 Base 'O' Ring
- R-291 End Cap Assembly

#### R-55

- R-393 Lens Ring
- TP-318 Glass Lens
- R-257 Heatsink LED Assembly
- R-225 R-55 Torch Body Assembly
- R-337 Clip Moulding
- R-287 Cassette Assembly (LED)
- R-243 Cassette Circuit Half (LED)
- R-271 Battery Pack
- R-488P Lock Screw Cassette (Pack of 2)
- TP-448 Base 'O' Ring
- R-291 End Cap Assembly

- TP-260 Wrist Strap & Ring
- R-620P Output Fuse
- R-640P Input Fuse (Pack of 2)

Fig. 16

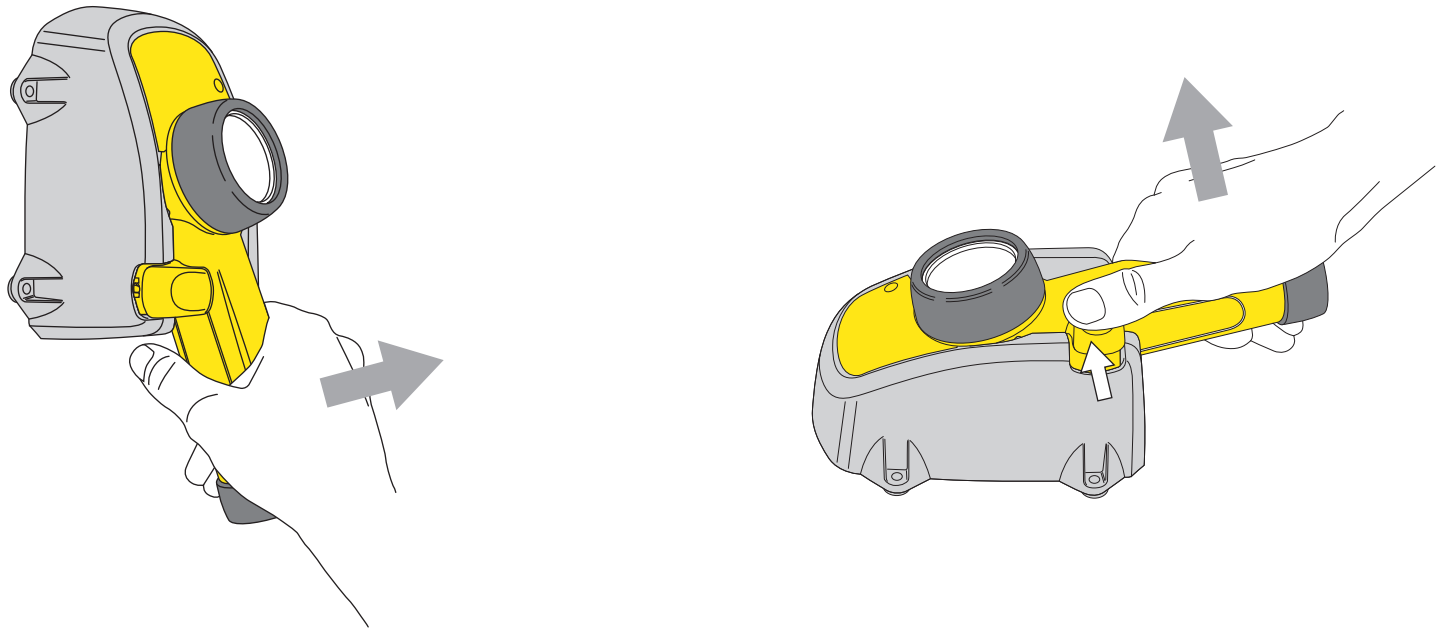
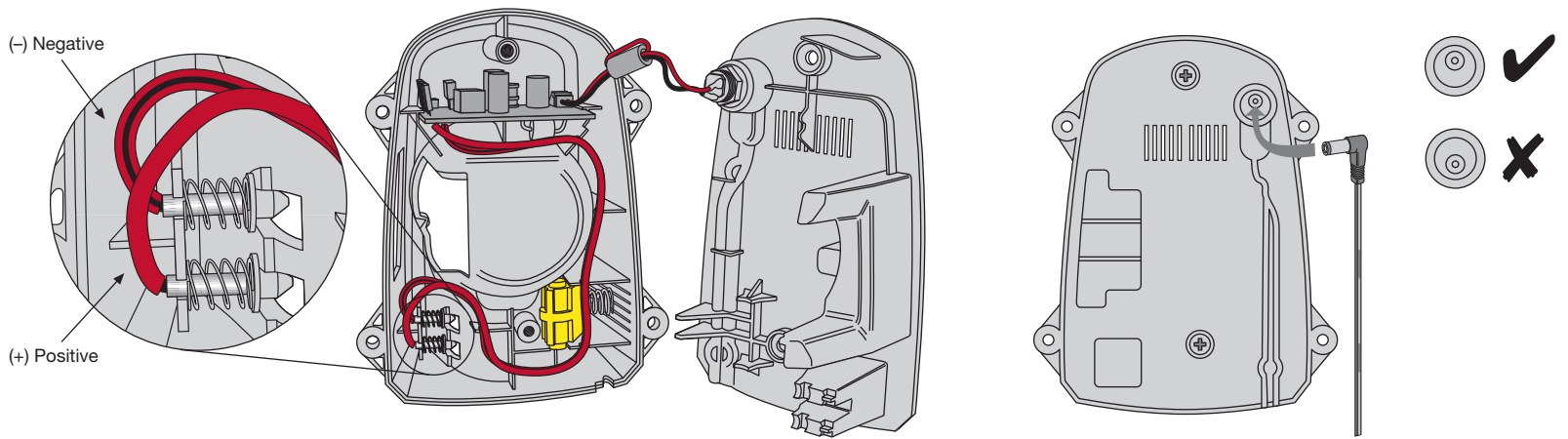
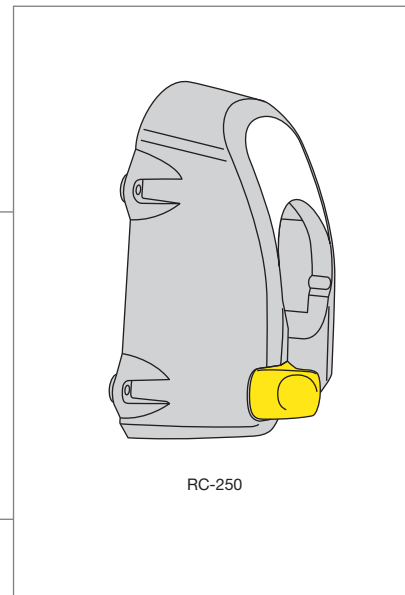
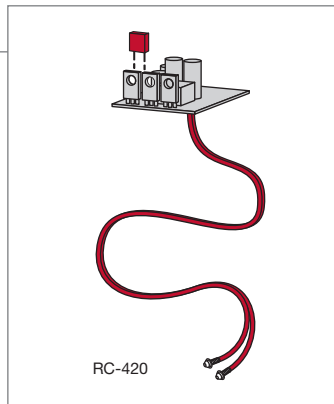
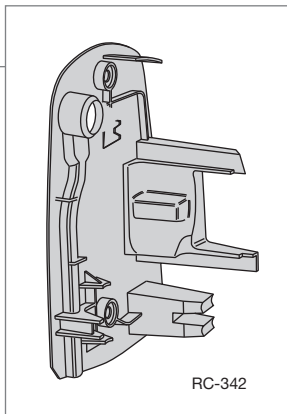

Fig. 17



## RC-200



### Parts List

#### RC-200

- RC-438P Charger Screw
- RC-342 Charger Base Plate
- RC-450 Socket and Cable
- RC-240 Charger Arm Assembly
- R-640P Input Fuse (Pack of 2)
- RC-420 Circuit Board Assembly (RC-200)
- RC-250 Charger Body Assembly (RC-200)

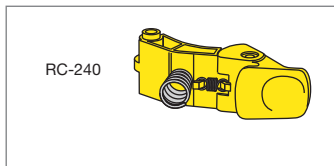
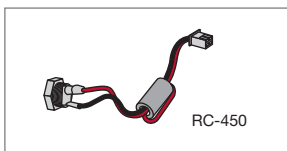

## RC-212

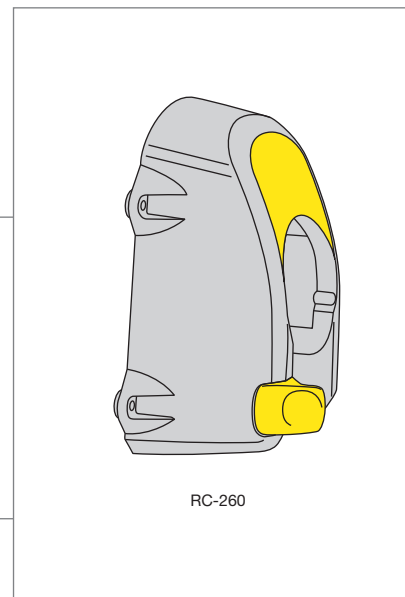
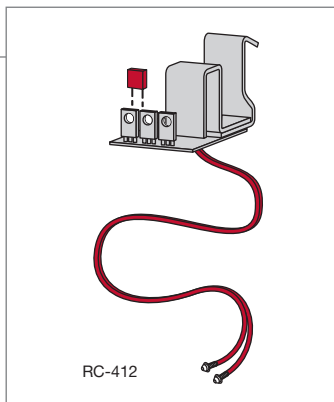
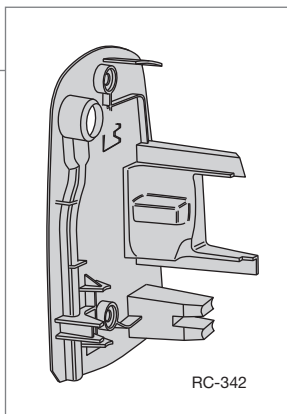

### Parts List

#### RC-212

- RC-438P Charger Screw
- RC-342 Charger Base Plate
- RC-450 Socket and Cable
- RC-240 Charger Arm Assembly
- R-640P Input Fuse (Pack of 2)
- RC-412 Circuit Board Assembly (RC-212)
- RC-260 Charger Body Assembly (RC-212)

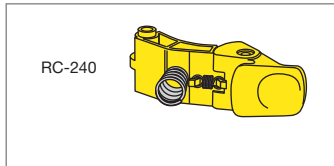
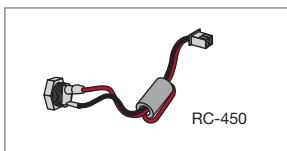

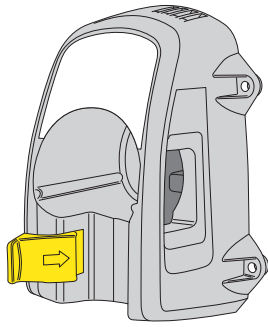

**RC-200**

12-24V DC

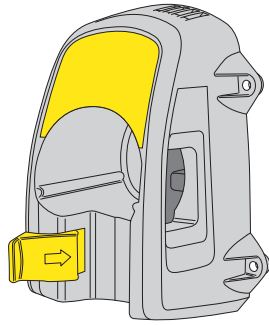
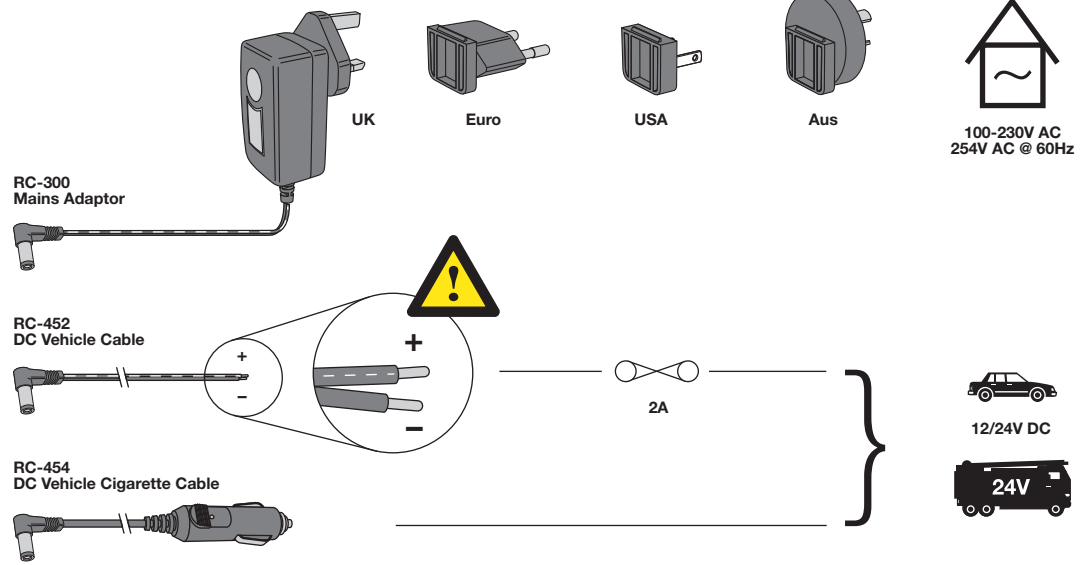

**RC-212**

12V DC ONLY

